



五、繩結



繩結

接棍結

- 功用
- 打法

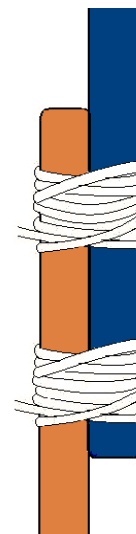
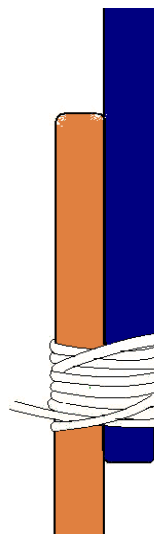
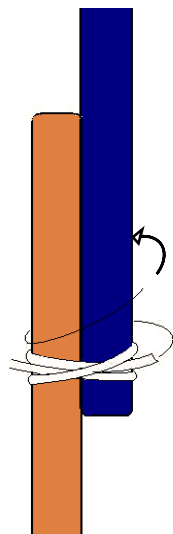

繩結



四方編結

- 功用
- 打法

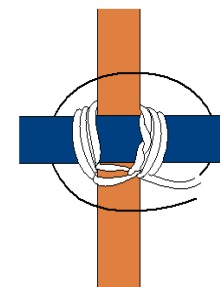
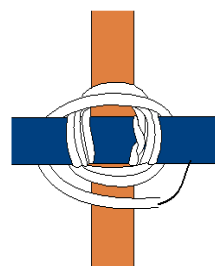
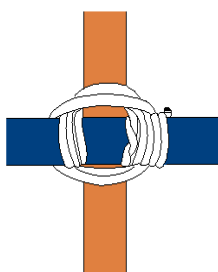
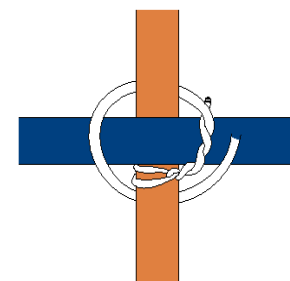
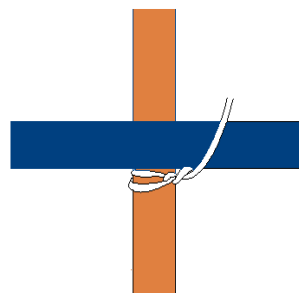

繩結



雙蛇編結

- 功用
- 打法

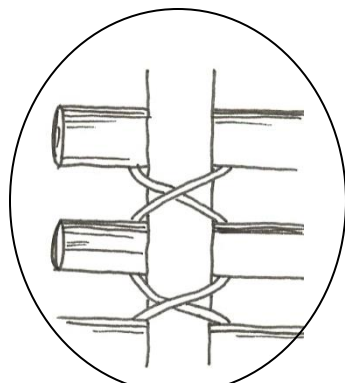

背面

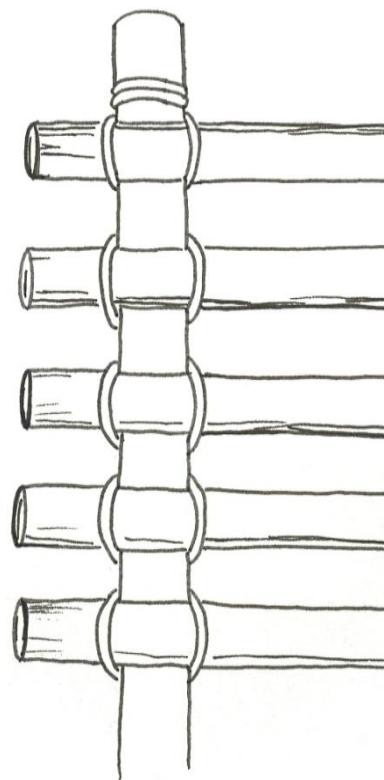

繩結



普通繩端結

- 功用
- 打法

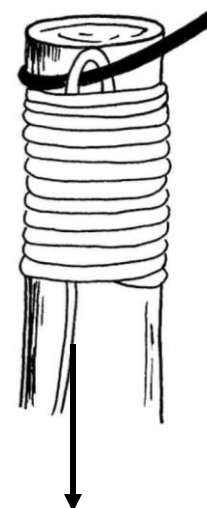
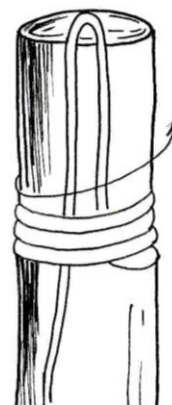
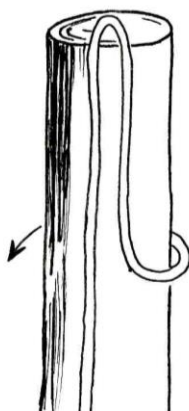

拉緊

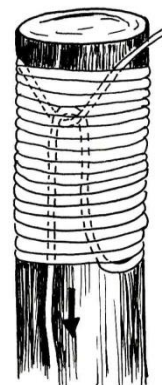

旗架一

主要繩結：

接棍結
四方編結

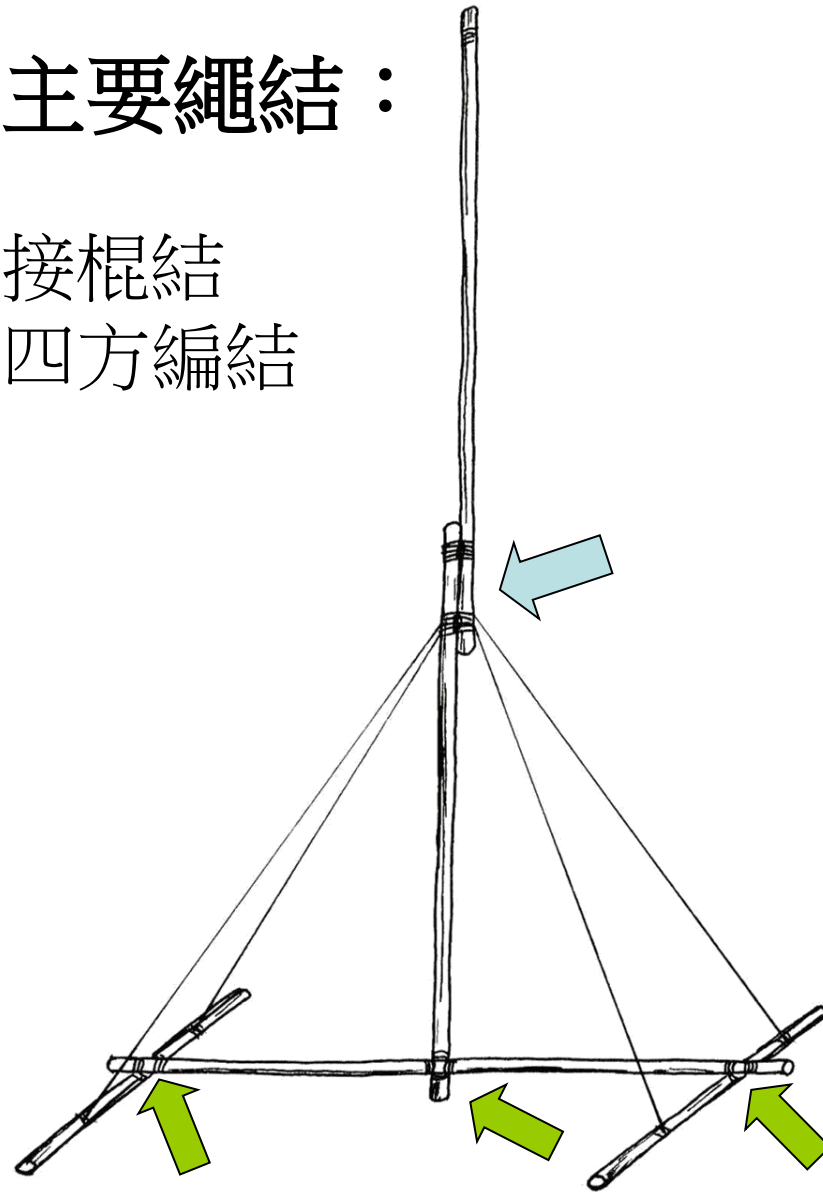

旗架二



主要繩結：

接棍結
瓶口結
雙套結

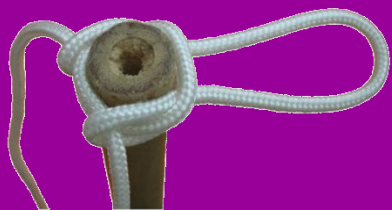
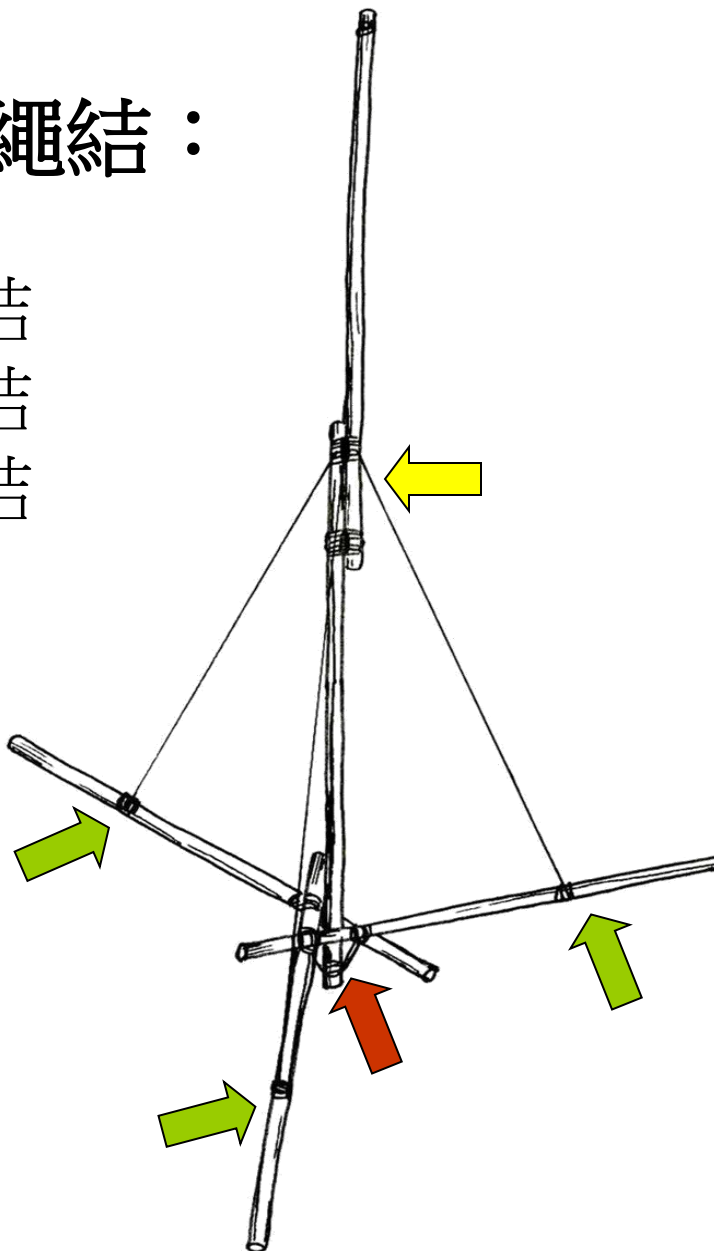

旗架三



主要繩結：

- 接棍結
- 帆工結
- 四方編結

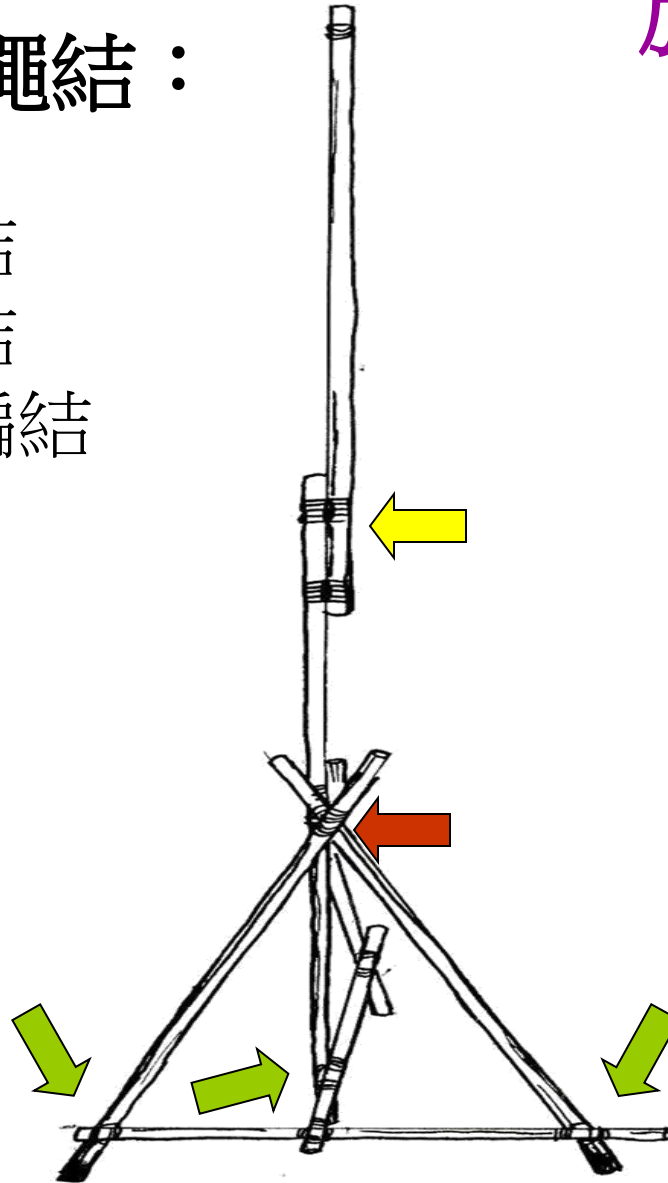

旗架四

主要繩結：

接棍結
帆工結
營釘結
雙套結

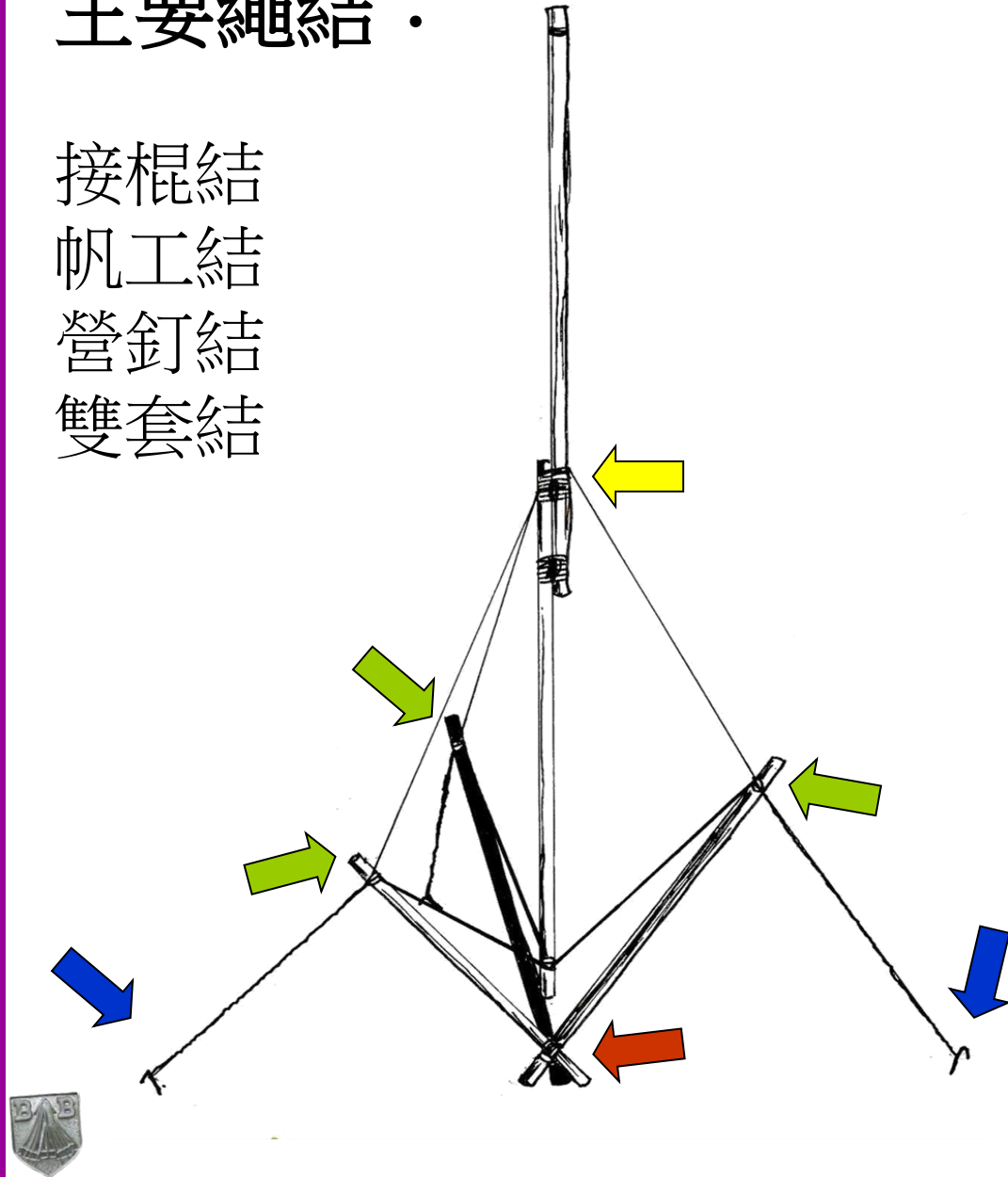

炊事檯

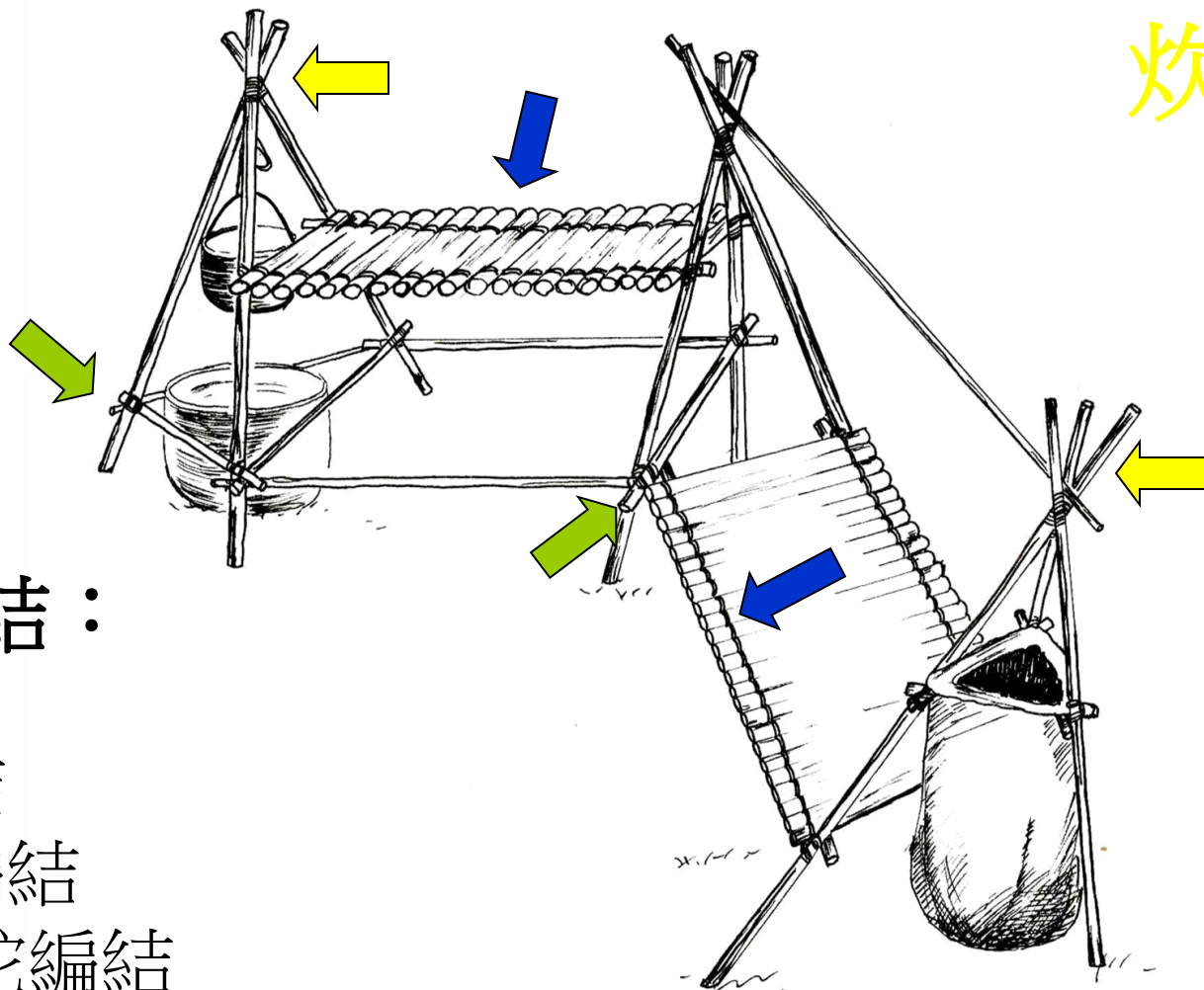

主要繩結：

- 四方編結
- 三腳架編結
- 雙蛇/單蛇編結

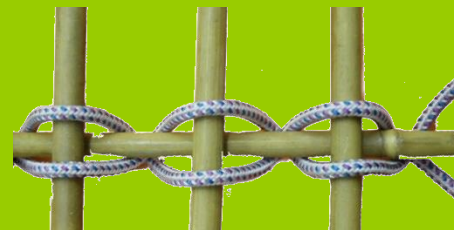

炊事檯(連天幕)

主要繩結：

接棍結

四方編結

雙蛇/單蛇編結

三腳架編結

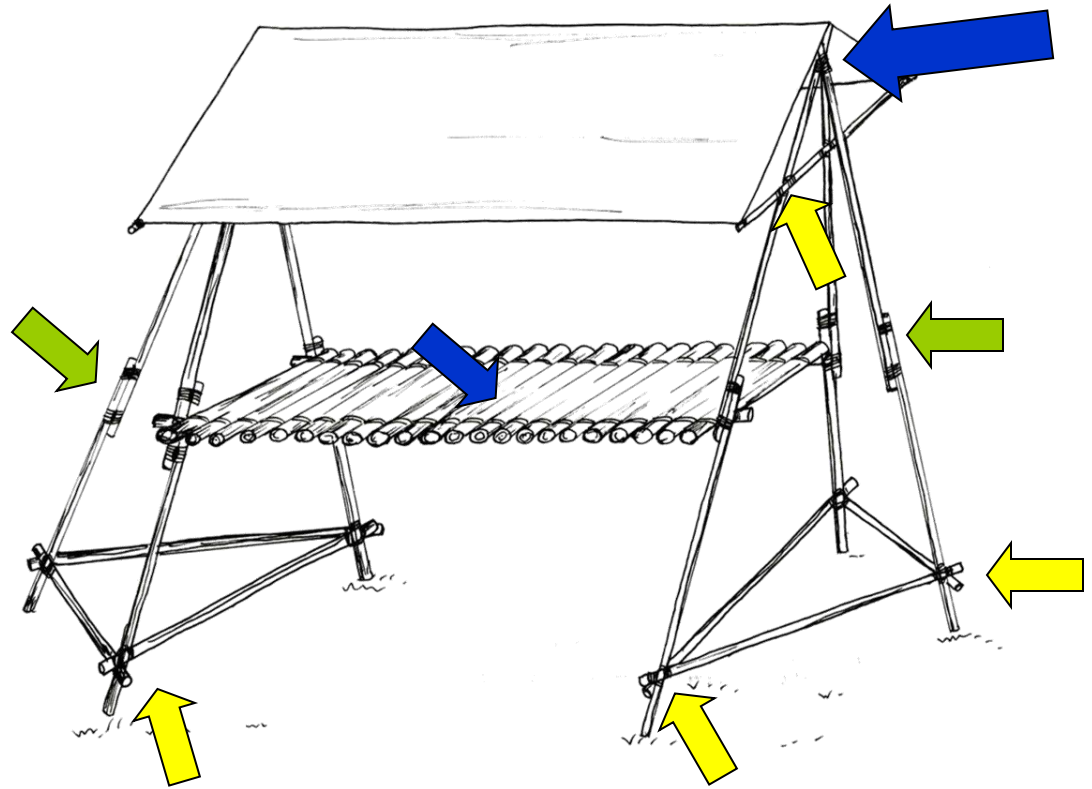

炊事檯

主要繩結：

雙蛇 / 單蛇結
三腳架編結
四方編結

